

Vectrex™

ARCADE SYSTEM



Owner's Manual

model HP-3000

GCE™
ENTERTAINING NEW IDEAS™

Congratulations on being a new owner of the Vectrex Arcade System. With Vectrex, you will experience the same fun and challenge of real arcade games right at home — arcade graphics, sounds and game play. That's because Vectrex has a special built-in arcade display, a real arcade control panel, an advanced arcade sound system and a powerful microprocessor.

An exciting and challenging new game — **Mine Storm™**— is built right into your new Vectrex Arcade System. A wide variety of outstanding Vectrex game cartridges are also available right now, including many real arcade favorites like Scramble,* Berzerk,†† and Armor Attack.** And many more games will continue to be introduced for your Vectrex. Watch for them at your favorite store.

We wish you many hours of good fun and challenge!

Important!

This owner's manual is important to you. Please read it. It shows you exactly how to operate your Vectrex Arcade System console so you can enjoy the superb game play you're entitled to. It can save you money too because it shows you simple things you can do and check before you call for help. It also contains your warranty. Please keep this booklet in a handy place for future reference.

™ Trademark of General Consumer Electronics, Inc.

* Trademark of and licensed by Konami Industry ©1981

†† Trademark of and licensed by Stern Electronics Inc. ©1980

** Trademark of and licensed by Cinematronics, Incorporated. ©1980

Unpacking

When you remove your Vectrex Arcade System from the box you should have these items:

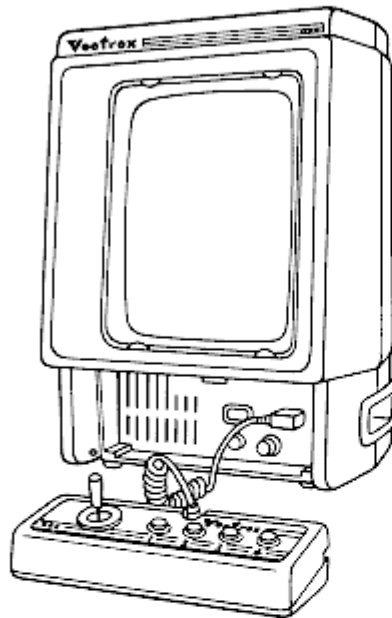

Vectrex Arcade System
Console with Built-in
Control Panel Attached



Owner's Manual



Owner's Club
Registration Card

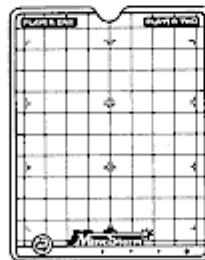

Screen Overlay & Instructions
for Mine Storm™ Game



It's a good idea to save the box and styrofoam inserts in case you ever need to move or ship your Vectrex Arcade System.

Setting Up

Your Vectrex Arcade System is designed for table-top use. For the most enjoyment, select a location where the screen will be at about eye level when you are playing the games. A sturdy table, desk or shelf is suggested. Do not operate the console on a bed, sofa, carpet, etc.

IMPORTANT: To prevent overheating, never block the ventilation openings on the back or bottom of the console. These openings have been designed to provide proper ventilation during operation and should not be enclosed or covered in any way.

Before inserting the plug, make sure the console switch is OFF. The unit will work in any 120 volt AC 60 cycle electrical outlet. Using any other power supply will damage the unit. As a special safety feature, the plug is polarized so that it will fit into standard AC outlets in one direction only. If the plug does not slip easily into the outlet, turn it over and insert again.

The Controls

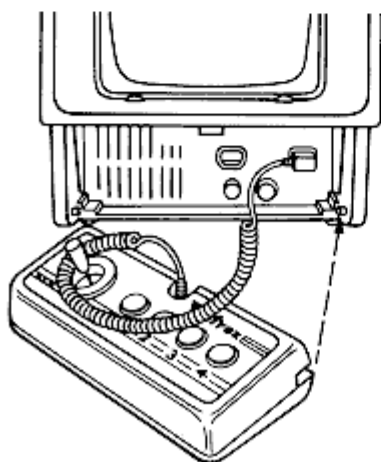

Control Panel Storage

To remove control panel from the storage area at the bottom of the console, press the release tab and the panel will drop down.

To return control panel to its storage area:

- Coil the cord **once** around the joystick and then on top of the action buttons.
- Slide the panel onto the tabs at the bottom of the console.
- Flip up the panel until it clicks into place.

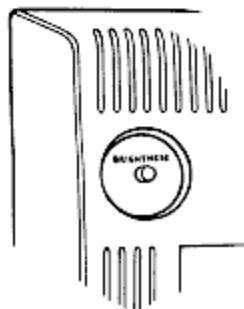
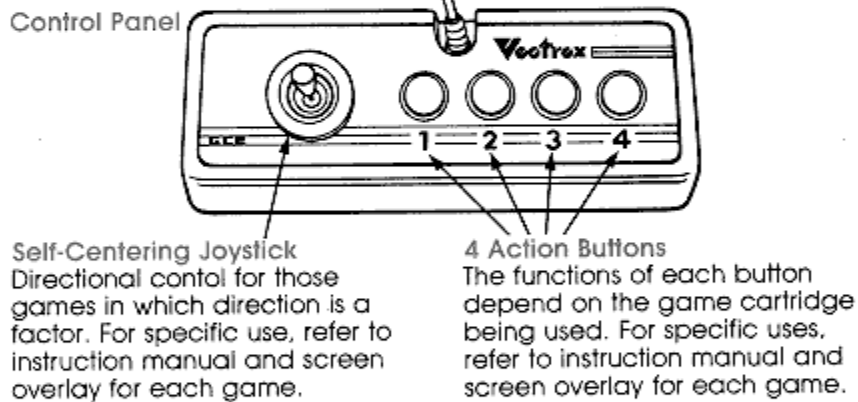
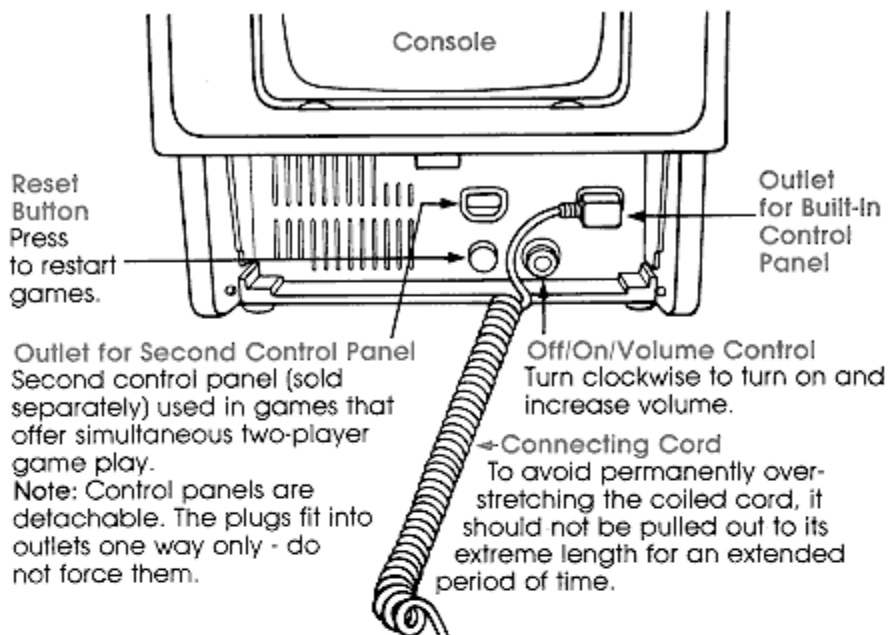

Brightness Control (on back of console)
Turn clockwise for brighter picture. Turn counter-clockwise to reduce brightness.

For maximum performance, brightness should be adjusted so that white dot does NOT appear in center of screen.

Inserting & Removing Game Cartridges

IMPORTANT: To prolong the life of your Vectrex Arcade System and protect the electronic components, the console should be turned OFF when inserting and removing cartridges.

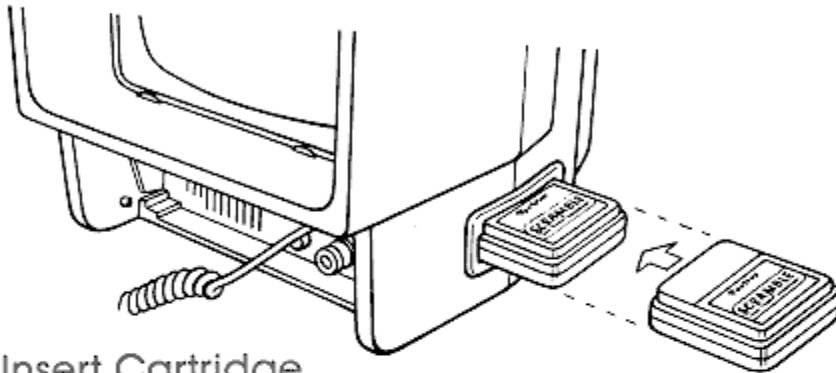

To Insert Cartridge

- Make sure the console's power is turned OFF.
- Hold the cartridge with the label side up.
- Insert cartridge carefully into the slot on the right side of the console.
- Be sure the cartridge is firmly inserted to the guideline marked on the cartridge.

To Remove Cartridge

- Make sure the console's power is turned OFF.
- Pull the cartridge straight out of the slot.
- To protect the electronic components, the cartridge should be stored in the original package or other suitable container.

IMPORTANT: Unlike a conventional TV screen, the screen built into the Vectrex console uses an advanced display technology to achieve brilliantly clear images and special visual effects like rotation and zooming. Due to this special display technology, it may appear that the images pulse slightly, especially in a room with fluorescent lighting. THIS SLIGHT PULSING IS NORMAL AND DOES NOT INDICATE A PROBLEM WITH YOUR CONSOLE. The screen overlays that are provided with each cartridge have been specially designed to virtually eliminate the slight pulsing.

Inserting & Removing Screen Overlays

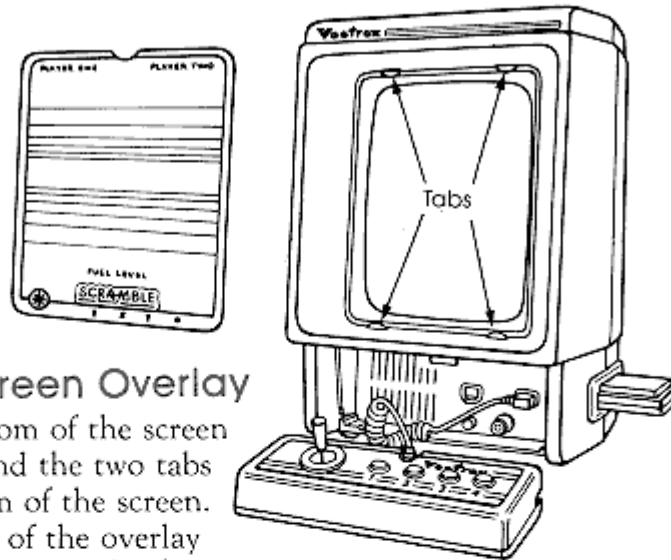

To Insert Screen Overlay

- Slip the bottom of the screen overlay behind the two tabs at the bottom of the screen.
- Push the top of the overlay down slightly using the finger area at the top and press against the tabs at the top until the overlay snaps into place under the tabs.

To Remove Screen Overlay

- Place your finger in the curved area at the top of the overlay, press down slightly and pull the overlay straight out.
- Store the overlay in the original package or other suitable container.

Starting Game Play

- Make sure the cartridge and overlay are inserted properly.
NOTE: A cartridge is not needed to play Mine Storm,[™] which is the game built into the console.
- Turn the Off/On/Volume Control to the ON position (clockwise). You will see the Vectrex title for a few seconds, then the name of the game.
- Adjust the volume control to the desired listening level.
- Refer to the individual game instructions for play details.

Maintenance and Safety Tips

Your Vectrex Arcade System will bring you many years of fun and excitement. In order to keep your Vectrex Arcade System in good working condition, please remember the following:

- Proper ventilation is very important to prevent overheating. Never block the ventilation openings on the back of the console in any way. There are also ventilation slots on the bottom which should not be blocked by placing the console on a bed, sofa, carpet, etc.
- Be careful not to spill liquids on the console, cartridges or control panel and never expose the unit to rain or excessive moisture. If this happens, unplug the console, wipe the outside dry, and then let the unit air dry for at least 48 hours before using it again.
- Do not expose the console, cartridges or control panel to excessive or extreme heat. Never place the unit near or over a radiator or heat system.
- Never remove the back cover of the console or drop or push objects through the slots in the back cover. This could expose you to very high voltage.
- If the console is damaged, a shock hazard may exist. If damaged or if there is a distinct change in performance, immediately unplug the console and have it checked by a GCE Authorized Service Center.
- Care should be taken not to drop the console, cartridges or control panel. The console should be lifted using the convenient handle at the upper rear of the console.
- Always turn the power OFF when the unit is not in use and before inserting or removing cartridges. Do not plug into a power source other than a 120 volt AC 60 cycles electrical outlet.
- Clean the screen overlays and the exterior of the console with a soft, slightly dampened cloth. Before cleaning the console, make sure the unit has been turned OFF and the power cord has been disconnected. Never use a household cleaner, cleanser or spray on the overlays or console.

Troubleshooting Checklist

No Picture and No Sound

- Console not plugged into a working electrical outlet.
- Power switch on console is OFF. Turn it ON.
- Check that the wall switch which controls outlet is turned on.

No Sound; Picture OK

- Volume control turned down. Turn it up, press Reset Button and listen for music at beginning of game.

No Picture; Sound OK

- Brightness control on back of console turned down. Turn control knob clockwise for brighter picture.

Built-In Game Plays OK but Cartridge Game Erratic, Stops Unexpectedly, or Extraneous Graphics Appear

- Cartridge may be defective. Try another one.
- Cartridge not inserted completely. Push cartridge into slot all the way to mark on plastic housing; push Reset Button and resume play.

Joystick or Action Buttons Do Not Work or Are Erratic

- Control panel plug is loose at console outlet. Push plug all the way into outlet.
- Built-in control panel plugged into outlet for second control panel. Always plug built-in control panel into the outlet on the right when playing games that require only one control panel.

Owner's Club

As a new owner of a Vectrex Arcade System, you are invited to join the Vectrex Owner's Club at **NO COST OR OBLIGATION**. As a member, you will periodically receive special discounts and other offers on Vectrex cartridges and a newsletter filled with information on upcoming new games, game winning tips, exciting contests and much more. It's absolutely free, and available only for Vectrex Owner's Club members. To join, just fill out the enclosed postage-paid Vectrex Owner's Club Registration Card and drop it in the mail.

TV and Radio Interference

The Vectrex console's electronic circuitry generates signals for its own internal use that may cause interference to nearby radio and television receivers. The Vectrex console has been type tested and is in compliance with FCC Rules Part 15 Subpart J for Class B computing devices. However, interference may occur in certain installations. If interference does occur, you should try one or more of the following measures to correct the problem:

- Reorient the TV or radio antenna
- Move the Vectrex console further from the TV or radio
- Plug the Vectrex console into a different outlet than the TV or radio
- Consult your Vectrex dealer or an experienced TV/radio technician for additional suggestions

A helpful booklet entitled "How to Identify and Resolve Radio-TV Interference Problems" is available from the U.S. Government Printing Office, Washington D.C. 20402, Stock No. 004-000-00345-4.

WARRANTY

90 DAY LIMITED WARRANTY VECTREX™ ARCADE SYSTEM

General Consumer Electronics (GCE) warrants to the original consumer purchaser (in the U.S.A.) of its Vectrex™ Arcade System that the product shall be free of defects in material or workmanship for 90 days from the date of purchase under normal in-home use.

During the warranty period GCE will, at its option, repair or replace the product without charge for parts or labor, when delivered to an Authorized Service Center with proof of the date of purchase. GCE reserves the right to utilize reconditioned parts in repairing the product or to utilize reconditioned units (carrying this same 90-day Limited Warranty) in replacing the product. Transportation or shipping charges to an Authorized Service Center are your responsibility.

This warranty does not apply if the product has been altered or repaired by anyone other than a GCE Authorized Service Center or has been subjected to purchaser abuse, accident, negligence, or damage subsequent to purchase.

Please read the Vectrex™ Owner's Manual carefully before using the product. If a malfunction occurs, please refer to the troubleshooting checklist in the Owner's Manual. If you cannot correct the malfunction after consulting the troubleshooting checklist, please call the following toll-free telephone number for help in solving the problem or to locate your nearest Authorized Service Center: 1-800-227-6900 (outside of California) or: 1-800-632-4777 (in California).

Units returned without proof of the date of purchase, or units returned after the 90-day warranty period has expired, will be repaired or replaced, at our option, for a service charge. Payments must be made by check or money order in the amount of the service charge made payable to the Authorized Service Center or to General Consumer Electronics, Inc. if returned to the GCE Factory Service Center.

This warranty excludes incidental or consequential damages resulting from the product or use of the product. (Some states do not allow the exclusion of incidental or consequential damages, so the above exclusion may not apply to you.)

This warranty gives you specific legal rights, and you may also have other rights that vary from state to state.

If you need service for your unit, it's available during and after the 90-day warranty period. For the fastest, most convenient servicing, simply follow these steps:

1. First call the following toll-free telephone number for help in solving the problem or to locate your nearest Authorized Service Center: 1-800-227-6900 (outside of California) or 1-800-632-4777 (in California).
2. If service is needed, you can **take** the product to your nearest Authorized Service Center or you can **send** it to the GCE Factory Service Center for repair. The appropriate addresses will be given to you when you call the numbers shown above.
3. If you wish to send the product to the GCE Factory Service Center, please follow these steps:
 - a. Pack the product carefully in its original box. If the box is not available, use a strong carton with plenty of newspaper or padding.
 - b. Enclose a brief note telling us the specific problem you are having with the unit. Include your name and address on the note. Also enclose proof of the date of purchase if during the 90-day warranty period. If the warranty period has expired, enclose check or money order for the service charge quoted by the toll-free operator or the GCE Factory Service Center.
 - c. On the outside of the carton, print the address given to you during your telephone call. Be sure to include your return address on the carton as well. Send the package by U.P.S. or Insured Parcel Post.

GCE[™]

A MILTON BRADLEY COMPANY

© General Consumer Electronics, Inc. 1982. Santa Monica, CA 90401.
All Rights Reserved. No. 98721-052